

# CASCADE<sup>™</sup>

## HANGING SCREENS

### INSTALL OPTIONS

Before work commences, please ensure you take the time to plan out your Cascade install, plan out your fixing points and the spacings of the screens.

**PATENT APPLICATION FOLDING AND EXPANDING DESIGN**

NZ 727634 | US 15/386635 | AU 2016273959 | GB 1621613.7 (publication number GB2547530)

Direct fixed top  
Free hanging base

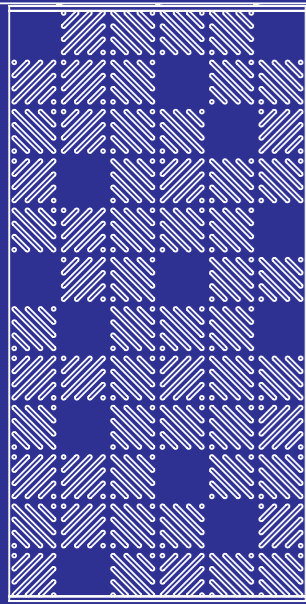

Direct fixed top  
Direct fixed base

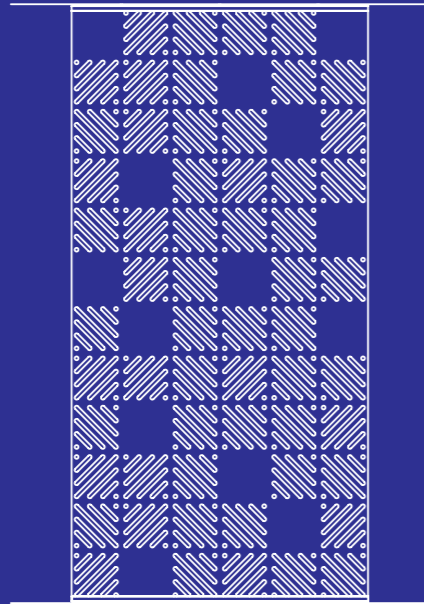

Direct fixed top  
Suspended base

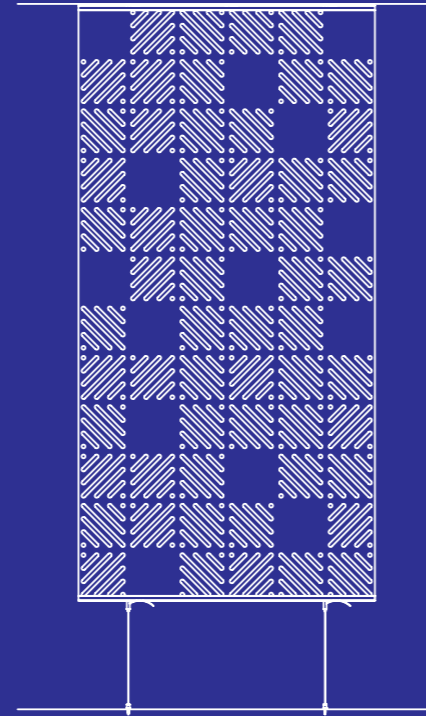

Suspended top  
Free hanging base

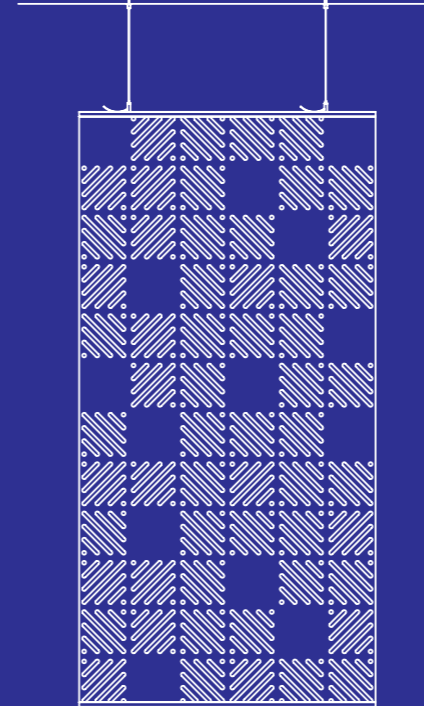

Suspended top  
Direct fixed base

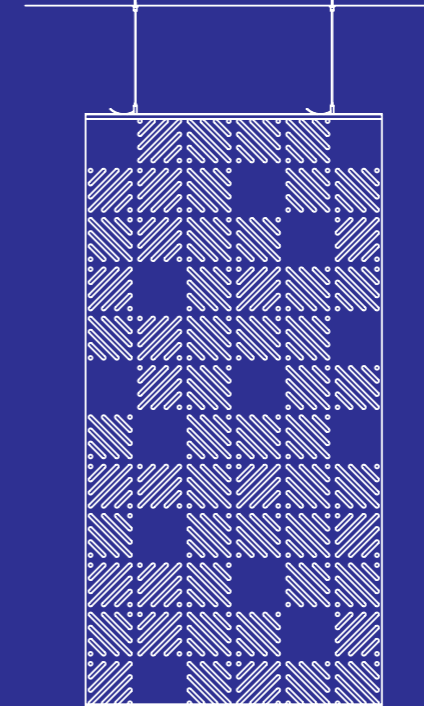

Suspended top  
Suspended base

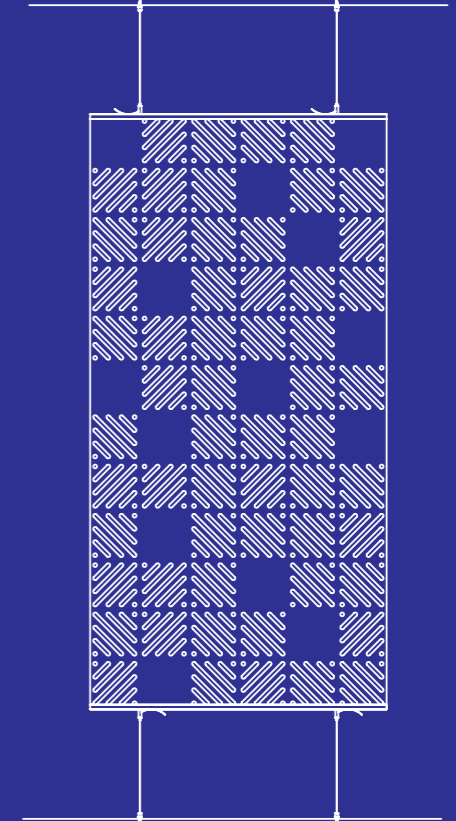

# CASCADE

## HANGING SCREENS

### SUSPENDED INSTALL INSTRUCTIONS

Before work commences, please ensure you take the time to plan out your Cascade install, plan out your fixing points and the spacings of the screens.

**PATENT APPLICATION FOLDING AND EXPANDING DESIGN**

NZ 727634 | US 15/386635 | AU 2016273959 | GB 1621613.7 (publication number GB2547530)

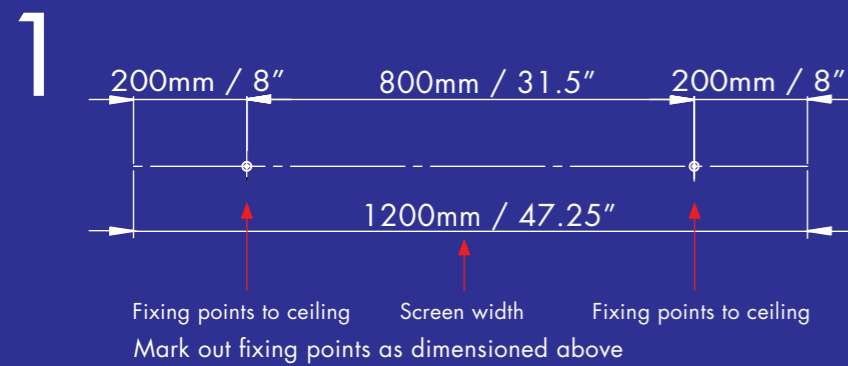

**2** Unscrew cap from ceiling connector base, screw the base part to the ceiling as marked out in step 1.

Thread the supplied cable through the cap so that the ball stop sits inside the cap.

Screw the cap back into the base.

Repeat for all instances.

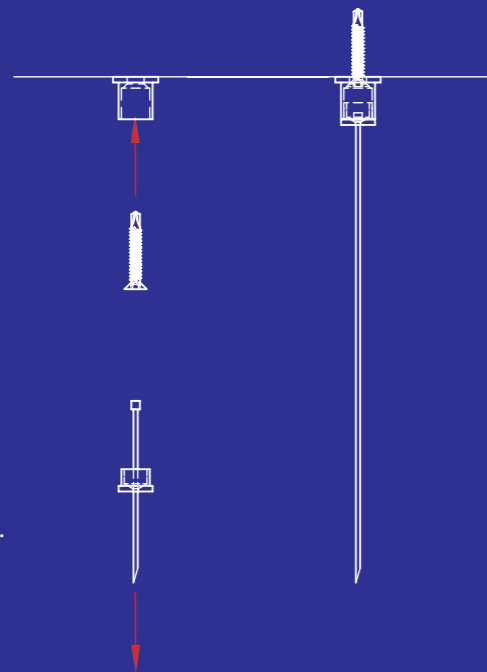

**3** Press extrusion firmly on to the top edge of the screen, ensuring a snug fit. If screen is to be fixed at the base, repeat as per the top.

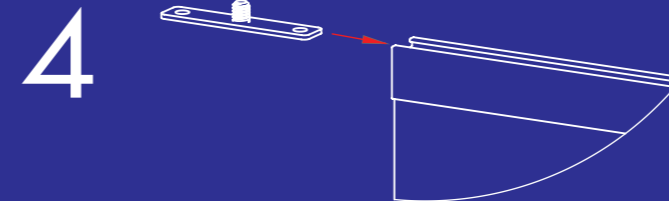
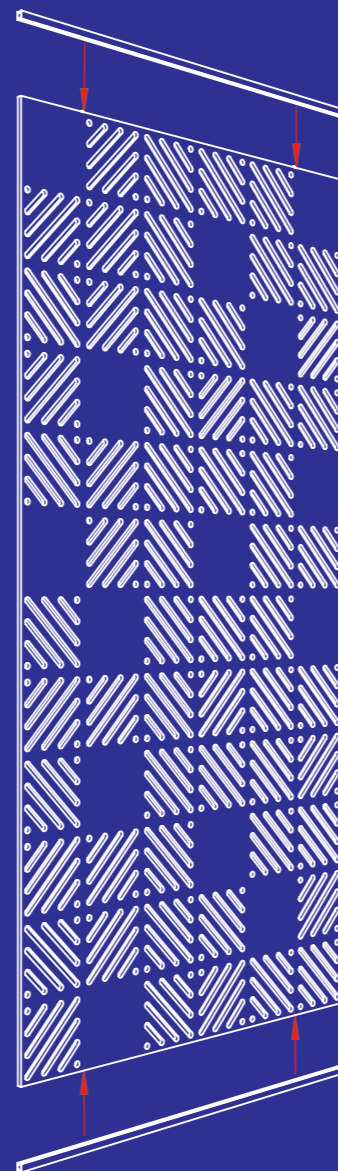

Slide connector plate into the top of the channel.

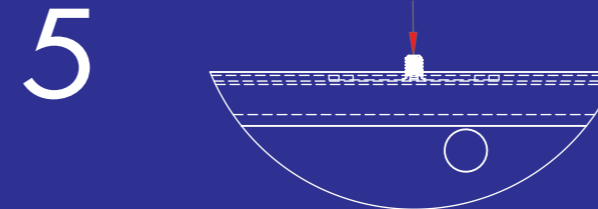

With the connector plate in position indicated in step 1 screw the adjustment barrel onto the threaded boss. Hand tighten to lock in position.

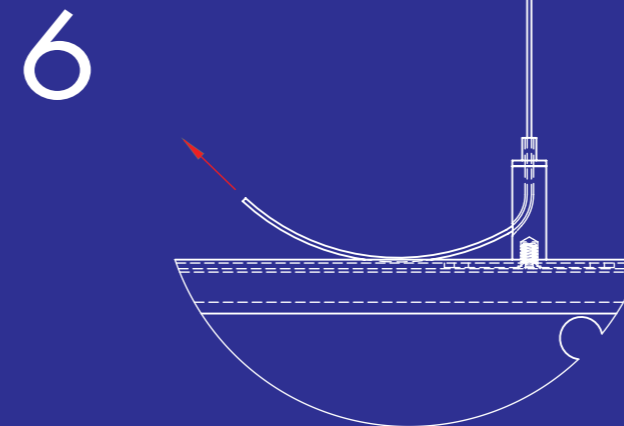

Lift screen up and thread the loose end of wire through each adjustment barrel as shown. Pull on the loose end to tighten or press down on top of the barrel to loosen.

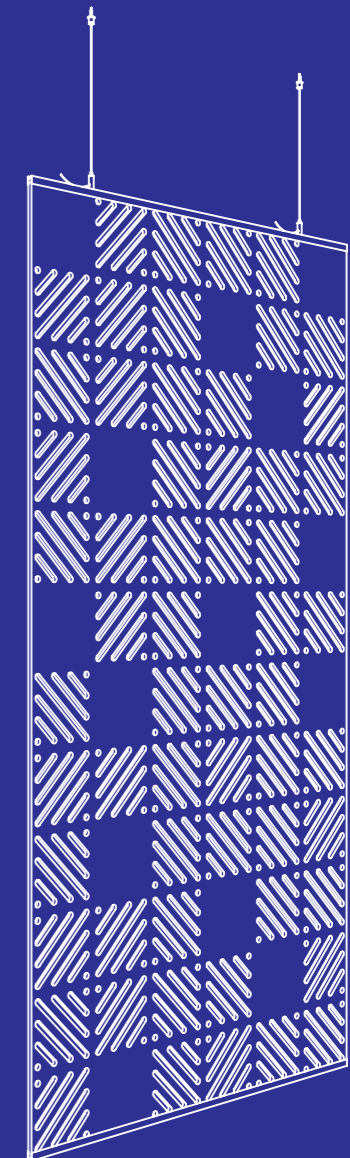

# CASCADE™ HANGING SCREENS

## DIRECT FIX INSTALL INSTRUCTIONS

Before work commences, please ensure you take the time to plan out your Cascade install, plan out your fixing points and the spacings of the screens.

### PATENT APPLICATION FOLDING AND EXPANDING DESIGN

NZ 727634 | US 15/386635 | AU 2016273959 | GB 1621613.7 (publication number GB2547530)

### PATENT APPLICATION PANEL FIXING ASSEMBLY

NZ 725770 | US 15/340100 | AU 2016250499 | GB 1618397.2 (publication number GB2545789 A)

1

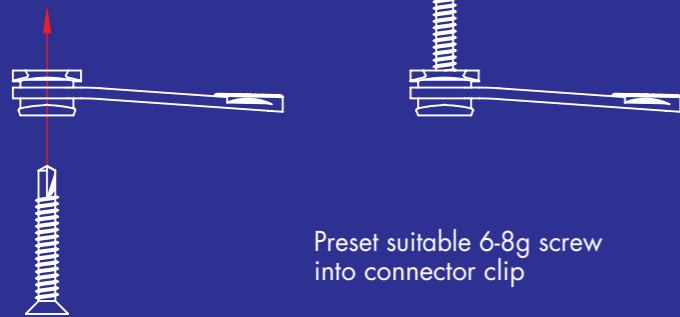

Preset suitable 6-8g screw into connector clip

3

Press extrusion firmly on to the top edge of the screen, ensuring a snug fit. If screen is to be fixed at the base, repeat as per the top.

2

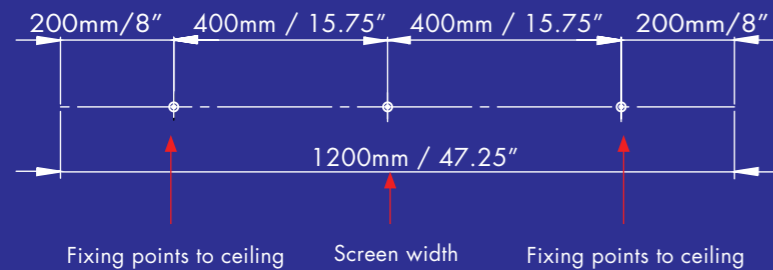

Mark out fixing points as dimensioned above and screw fixings into place.

NOTE: It is important not to overtighten the screws. The connector should be firm, but able to be rotated on the screw.

4

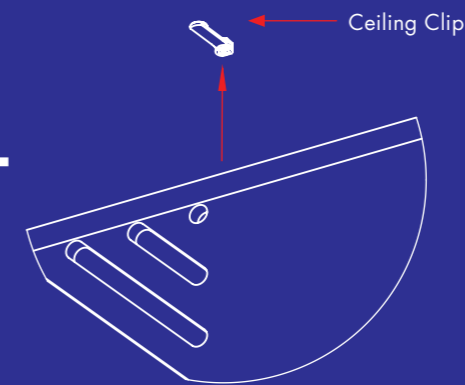

Ceiling Clip

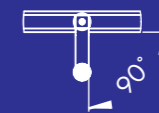

Offer up the screen to the installed connectors with the clip at 90deg to the screen.

Press ceiling clip into channel.

5

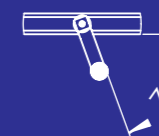
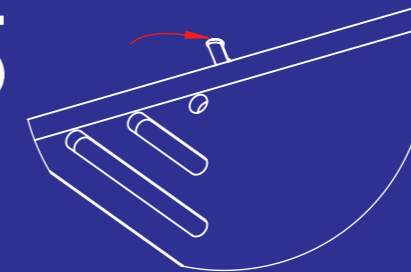

Twisting the connector handle slightly will prevent screen falling, but still allow fine adjustment of the screen left or right.

6

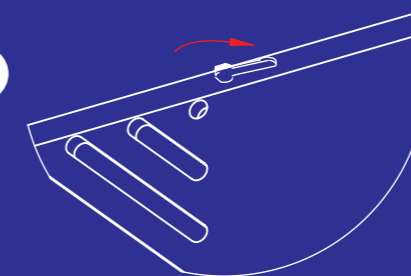

Twist connector until the handle snaps into the channel to lock screen in position.

